

edilportale[®]

TOUR 2018

Efficienza Energetica, Antisismica,
Comfort Abitativo, NTC2018, Illuminazione,
Acustica, BIM, Realtà Virtuale

FERRARA, 10 aprile 2018

I SISTEMI A SECCO PER IL COMFORT ACUSTICO E L'EFFICIENZA ENERGETICA NELLA RISTRUTTURAZIONE

Ing. Jonathan Di Tommaso

Technical Sales Manager Emilia Romagna-Marche

Perché Costruire a Secco

- Elevate Prestazioni termo-acustiche
- Confort abitativo elevato – regolazione igrometrica naturale
- Rapidità di posa
- Eliminazione delle assistenze murarie
- Riduzione dei costi
- Flessibilità e versatilità: si adatta a strutture in legno-acciaio-c.a.
- Libertà progettuale
- Leggerezza
- Sistema antisismico
- Protezione antincendio
- Sostenibilità Ambientale



RISPARMIO ECONOMICO

- Costi complessivi dell'edificio inferiori.



SOSTENIBILITÀ

- Maggiore rispetto per l'ambiente grazie al minore consumo di risorse naturali.



PRESTAZIONI

- Maggiori prestazioni a parità di spessore.



SISTEMA A SECCO PER ESTERNO

KNAUF INVOLUKRO

Sistema AQUAPANEL®
Leggerezza, resistenza e versatilità

Pareti di tamponamento

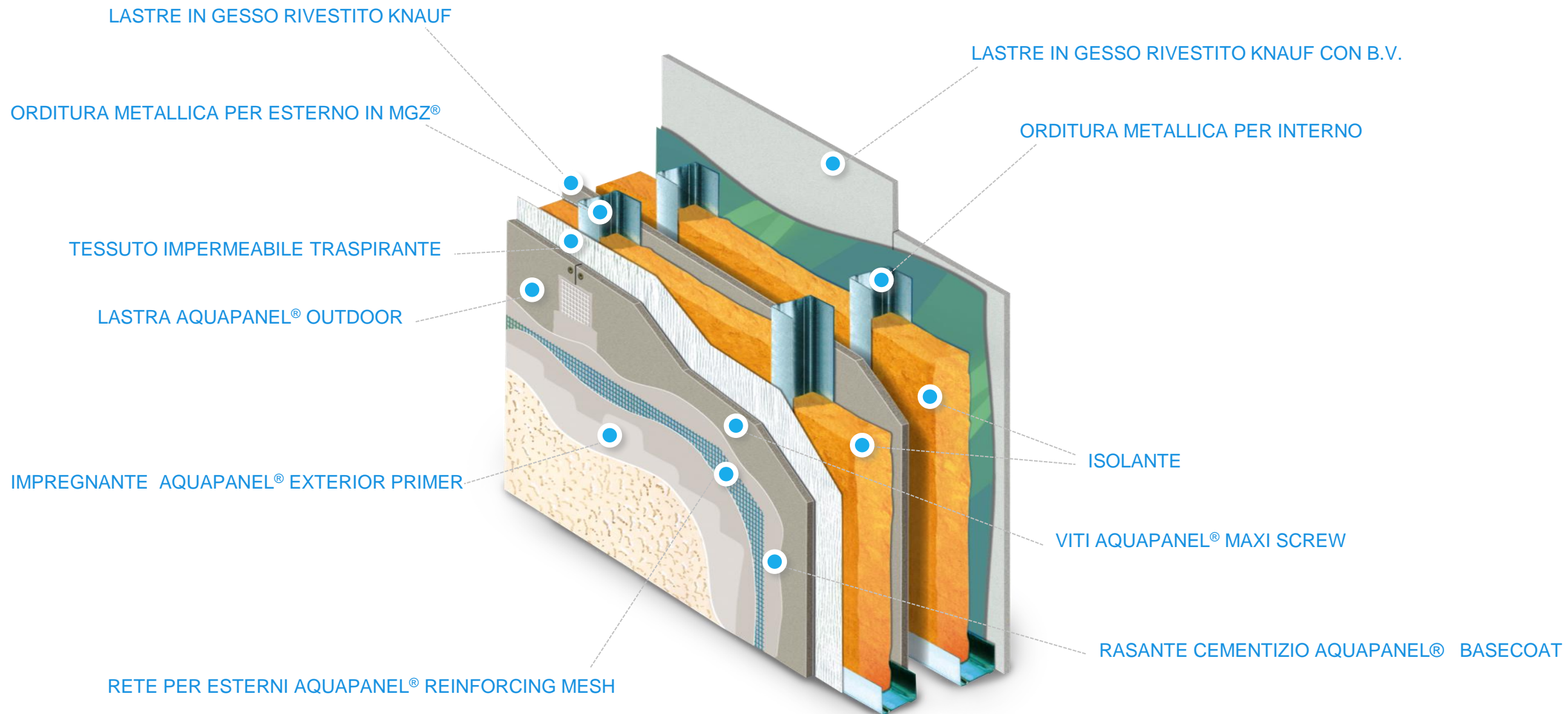

Esempio 1:

Le applicazioni: pareti di tamponamento - prestazioni

PONTI TERMICI SOLAIO/PILASTRO/TRAVI

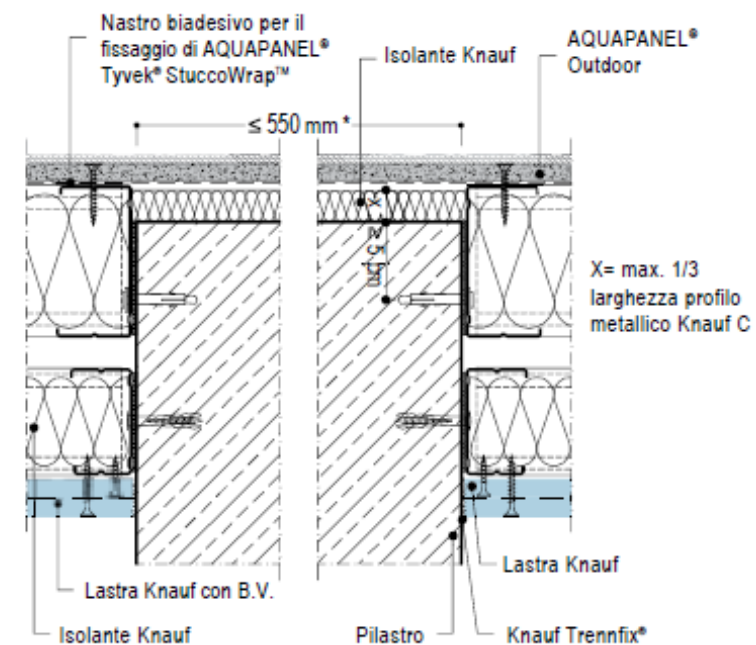
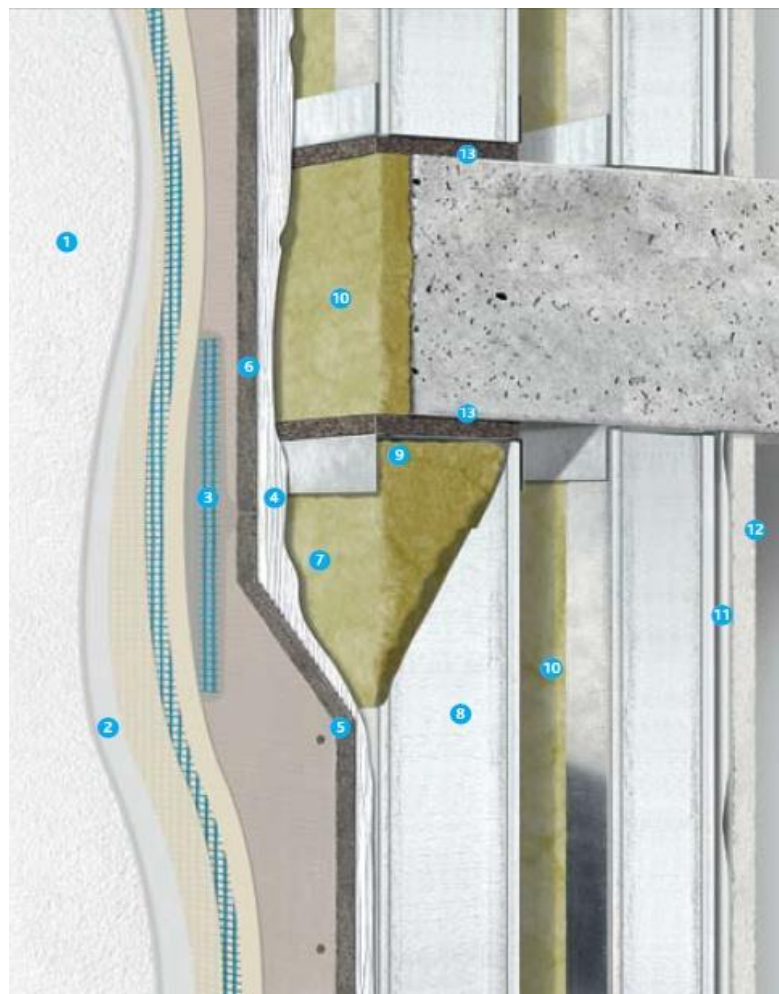
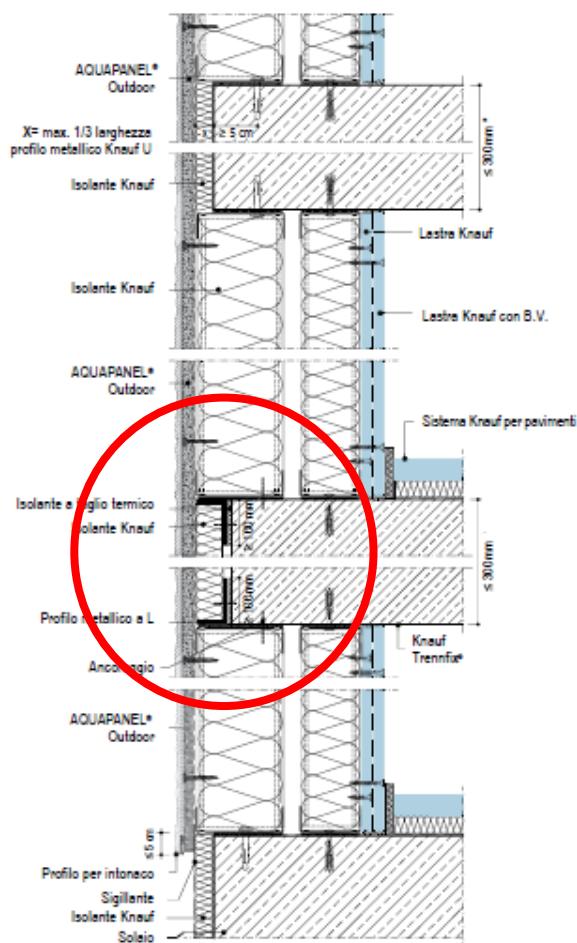

Le applicazioni: pareti di tamponamento - prestazioni

PONTI TERMICI SOLAIO/PILASTRO/TRAVI

Esempio 2:

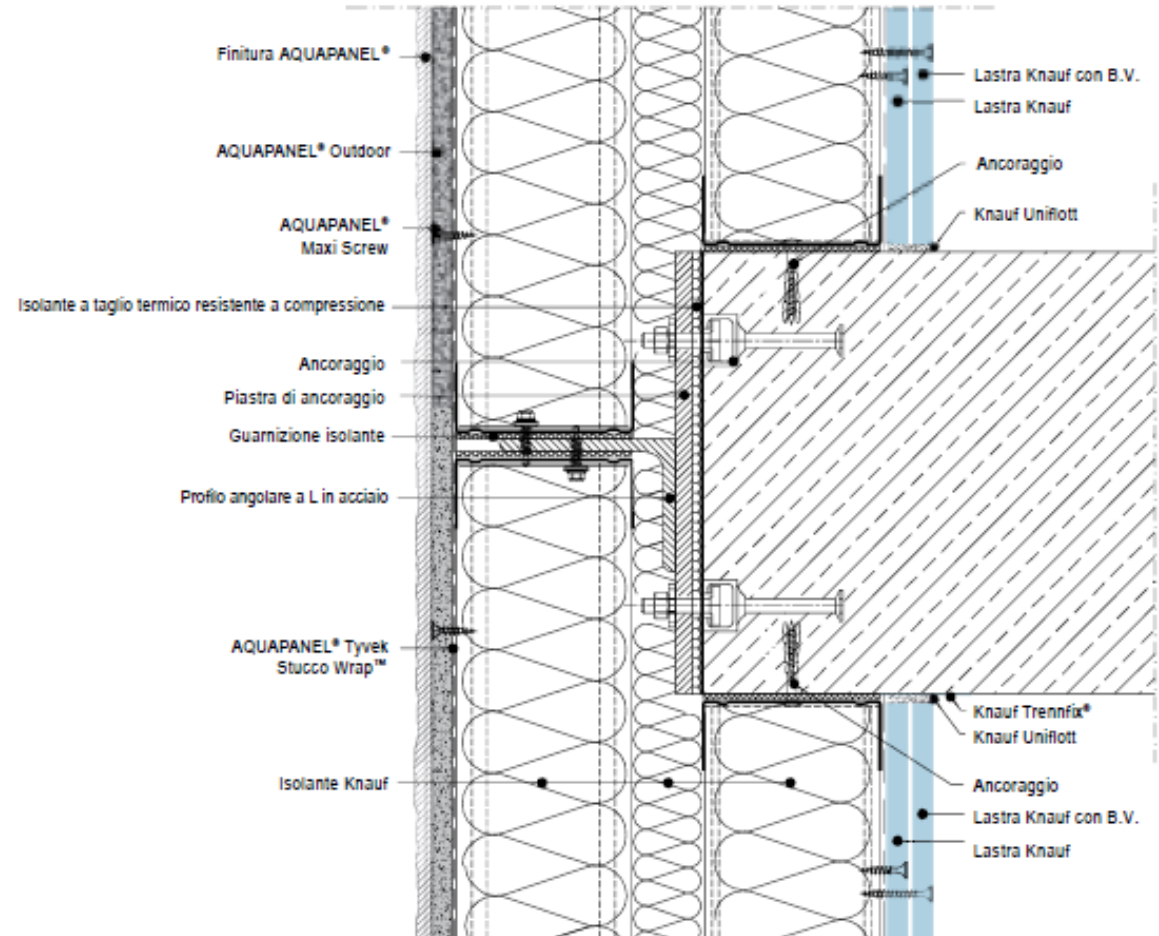
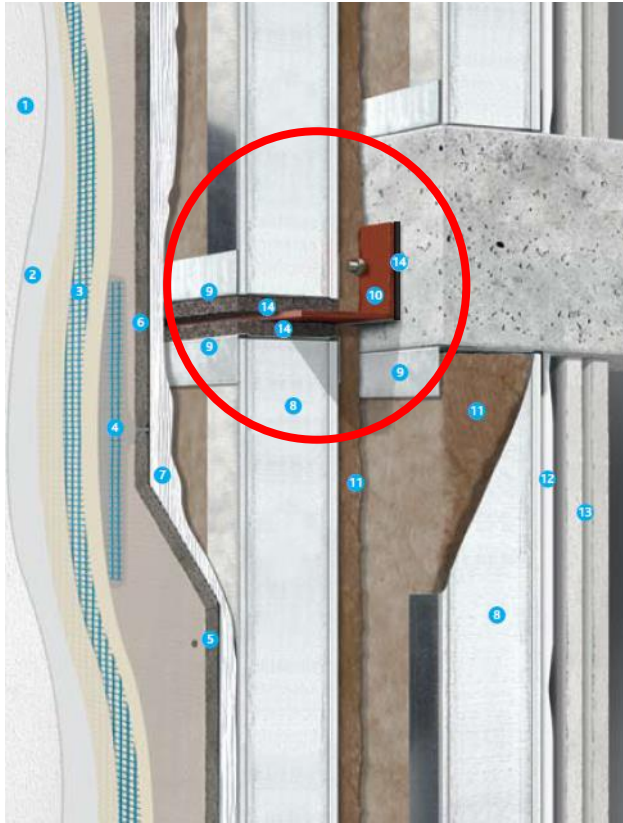

Le applicazioni: pareti di tamponamento - prestazioni

ESEMPIO DI APPLICAZIONE SISTEMA AQUAPANEL + SISTEMA CAPPOTTO TERMICO

Esempio 3:

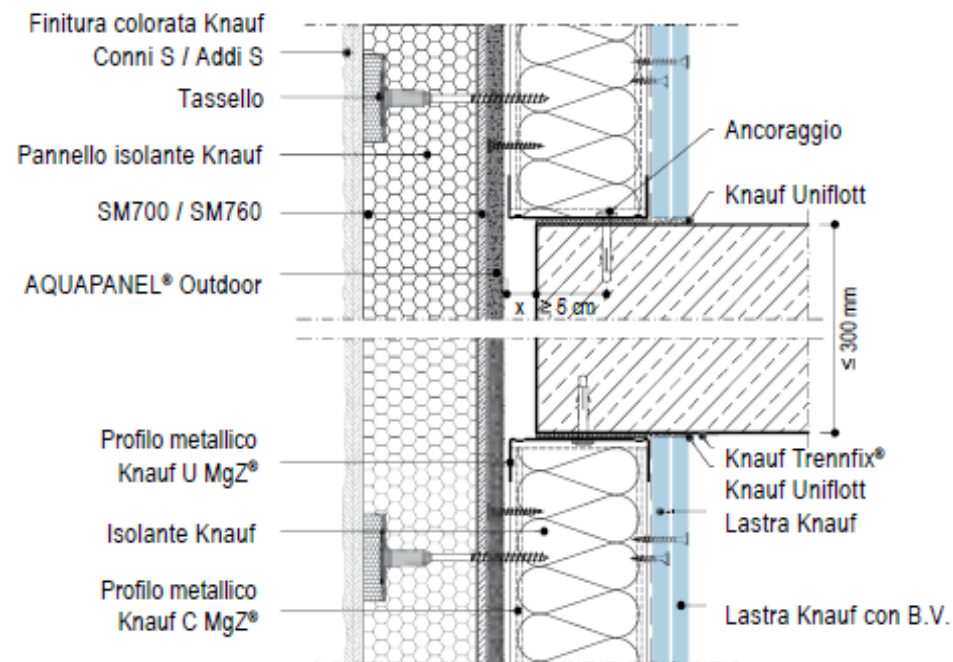

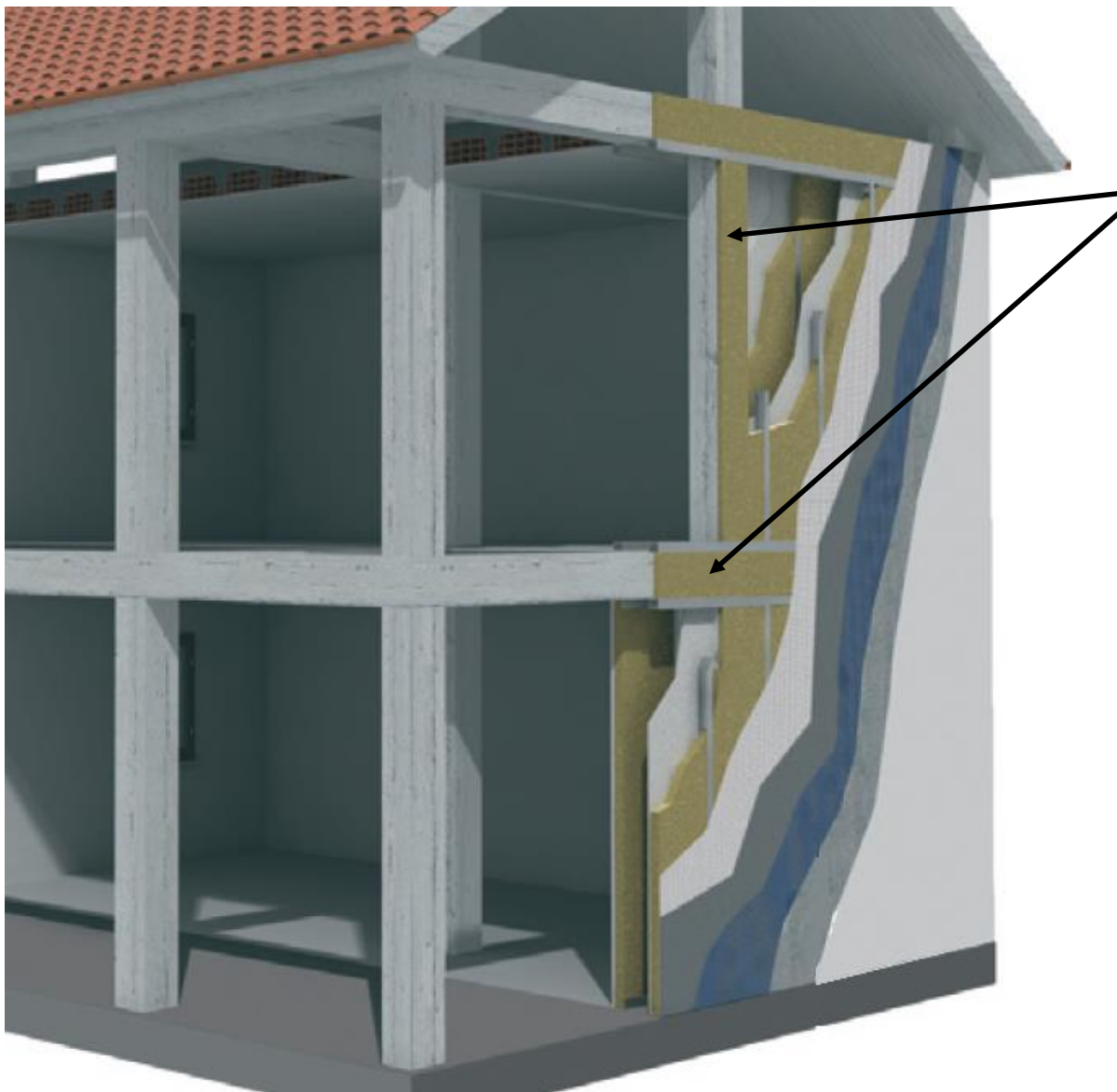

Correzione del ponte termico in corrispondenza dei pilastri e dei solai

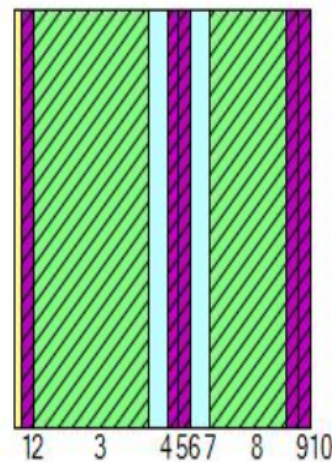

Struttura:

Dati generali

Spessore totale	0,311 m
Massa superficiale	100,1 kg/m ²
Massa superficiale esclusi intonaci	86,1 kg/m ²
Resistenza	6,52 m ² K/W
Trasmittanza	0,153 W/m ² K

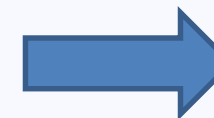

Parametri dinamici	Valori invernali	Valori estivi
Trasmittanza periodica	0,042 W/m ² K	0,042 W/m ² K
Fattore di attenuazione	0,274	0,273
Sfasamento	9h 43'	9h 54'
Capacità interna	24,5 kJ/m ² K	24,6 kJ/m ² K
Capacità esterna	29,0 kJ/m ² K	28,4 kJ/m ² K
Ammettenza interna	1,745 W/m ² K	1,751 W/m ² K
Ammettenza esterna	2,074 W/m ² K	2,029 W/m ² K





Inside Arch - Concave, outside Arch - Convex

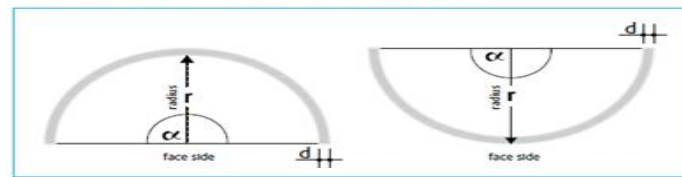

Board thickness d	Bending radius r of AQUAPANEL® Cement Board Outdoor	
	Width 300 mm	Width 900 mm
mm	mm	mm
12.5	≥ 1000	≥ 3000

Length of layout-L		
Angel α 90° $L = \frac{r \cdot \pi}{2}$	Angel α 180° $L = r \cdot \pi$	All angles up to α 180° $L = \frac{\alpha \cdot r \cdot \pi}{180}$



Installation of AQUAPANEL® Cement Board Outdoor with different radius

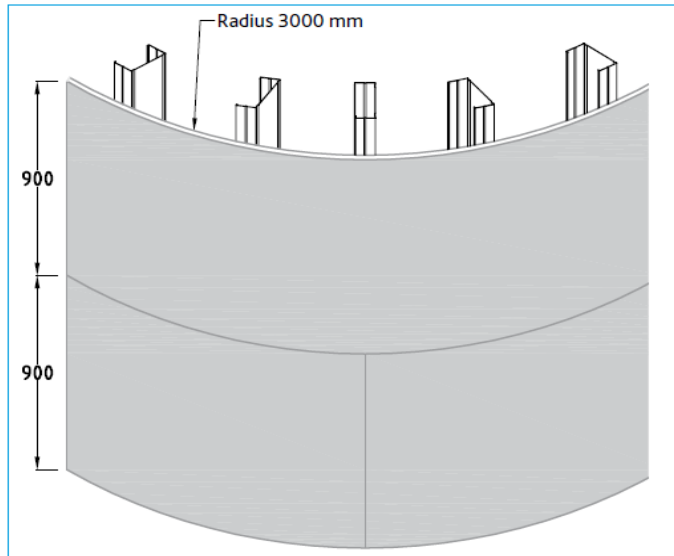

Assembly with 900 mm width panels for $r \geq 3.0$ m

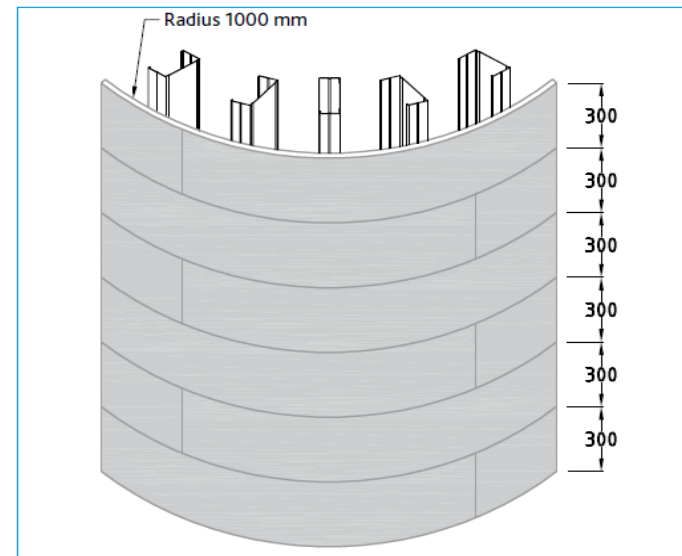

Assembly with 300 mm width panels for $r \geq 1.0$ m

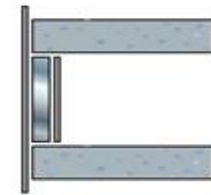

Montante singolo

Capannone Industriale



Ampliamento di una Villa con Piano Casa



Ampliamento di una Villa con Piano Casa



Ampliamento di una Villa con Piano Casa



Complesso pastorale



Complesso pastorale



Complesso pastorale





SISTEMA ISOLAMENTO TERMOACUSTICO PER INTERNI



Sistema Isolamento Interni
L'evoluzione del comfort termo-acustico

Per isolare bene: il concetto di una cella nella cella

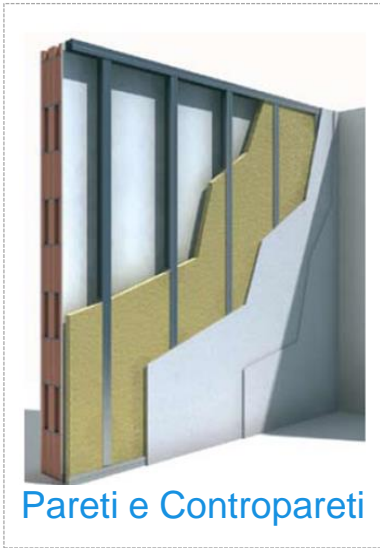
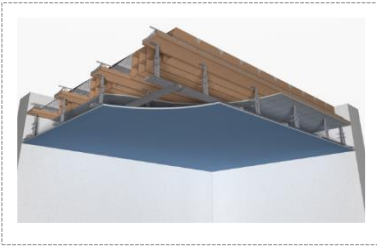

Pareti e Contropareti

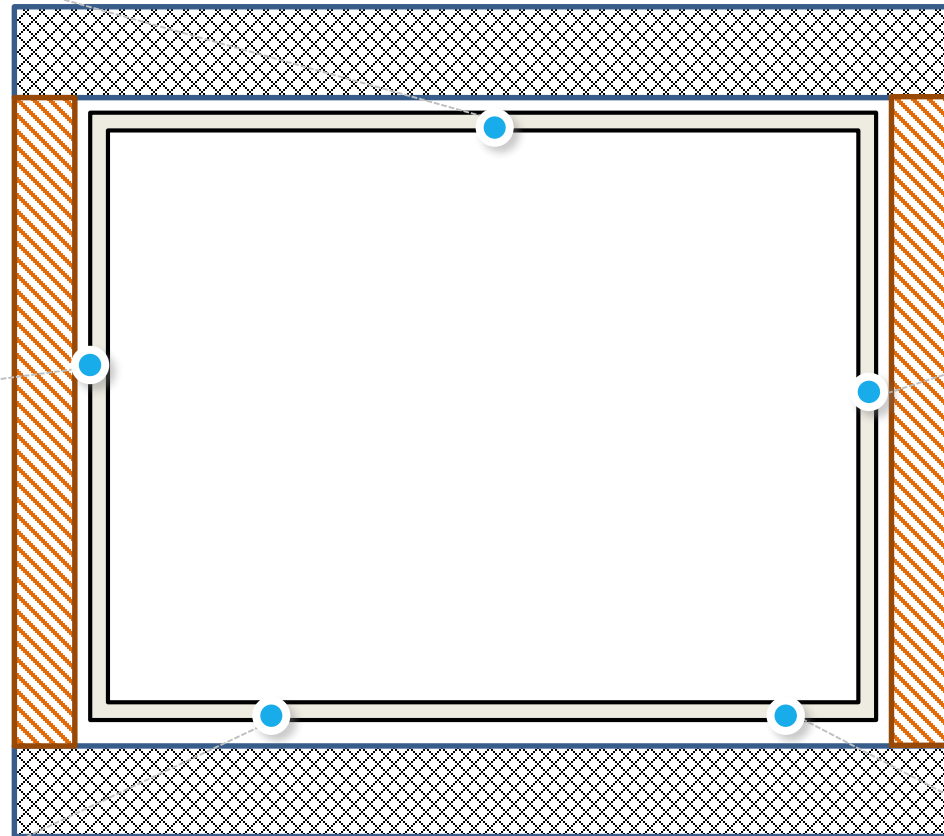
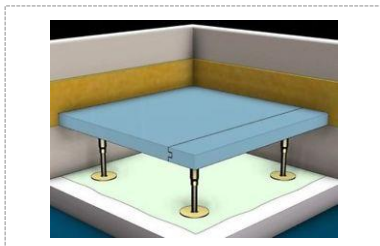

Rivestimento isolante W624

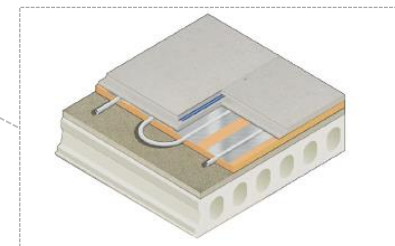

MODELLO DI PARETE – CONTROPARETE - CONTROSOFFITTO

SISTEMA MASSA - MOLLA - MASSA



Le formule, di carattere generale, che esprimono le frequenze di risonanza sono le seguenti:

$$f_r = \frac{c}{2\pi \cos\phi} \cdot \sqrt{\frac{mv}{d} \cdot \left(\frac{1}{W_{p1}} + \frac{1}{W_{p2}}\right)}; \quad f_s = n \cdot \frac{c}{2d \cos\phi}$$

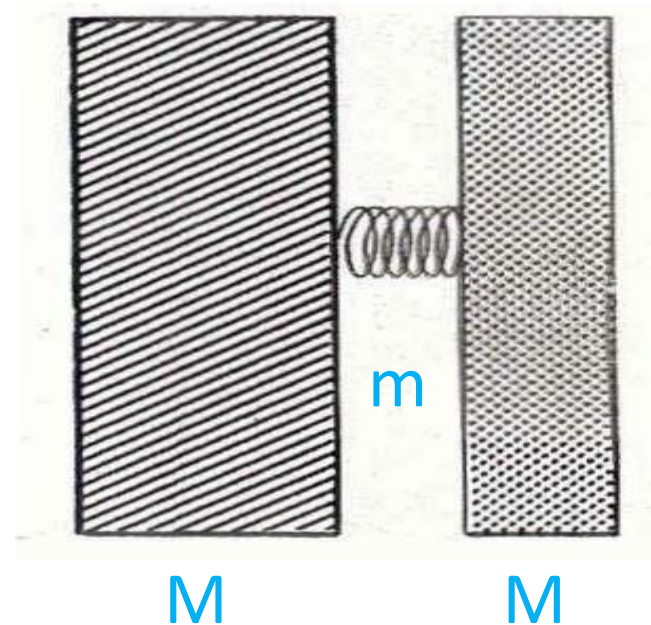

L'effetto di coincidenza nelle pareti dipende essenzialmente dalla frequenza critica del pannello considerato e può essere calcolato con la seguente espressione (UNI 7170):

$$f_c = \frac{c^2}{1,8h} \cdot \sqrt{\frac{\delta}{E}}$$

Obiettivi minimi di Qualità

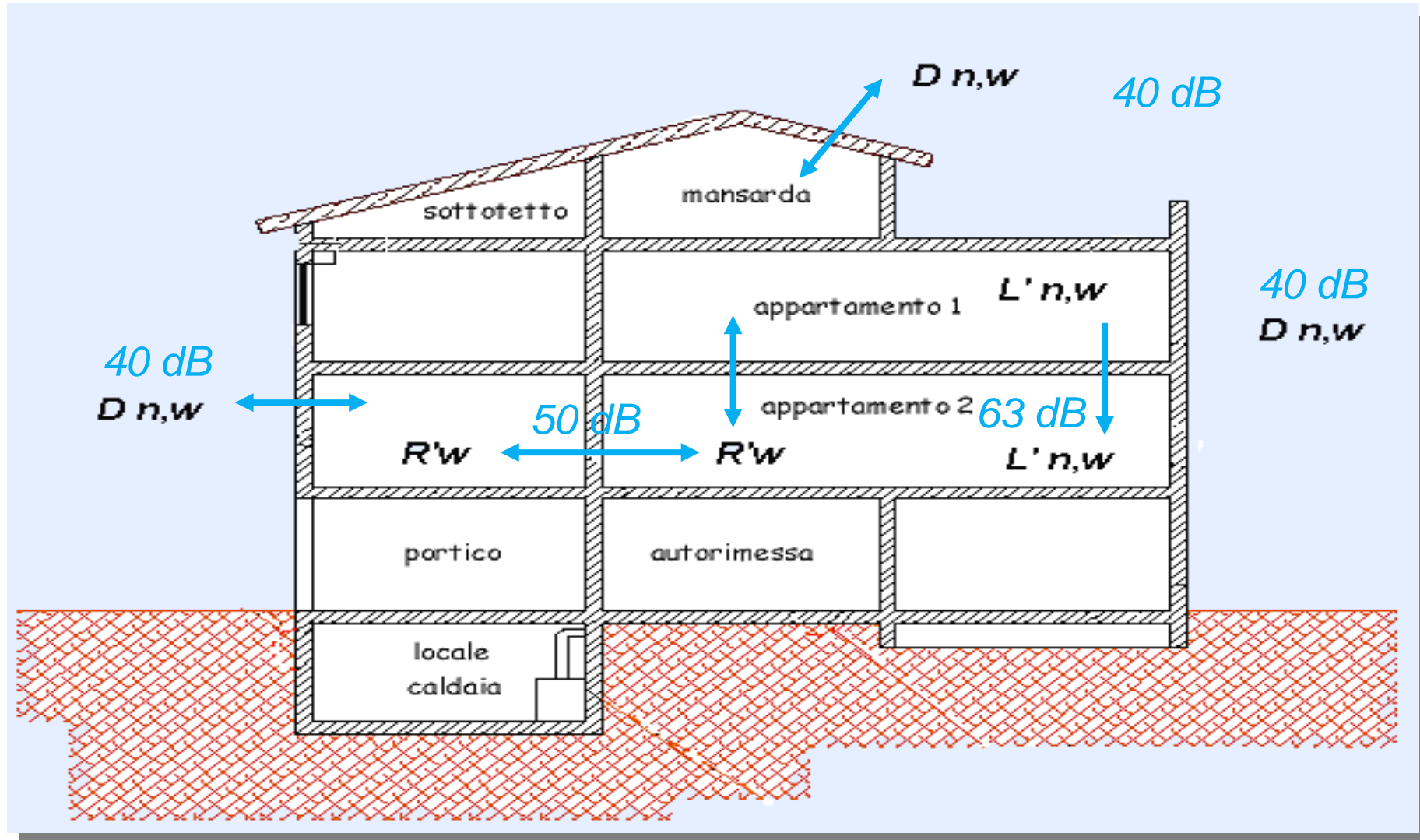

Alcune soluzioni: Le contropareti



- Muratura
- Isolante Knauf in lana minerale
- Profilo Knauf C Plus 27/50/27 mm, ad interasse 600 mm
- 1 Lastra Knauf GKB, spessore 12,5 mm (A13) con interposta barriera al vapore in lamina di alluminio spessore 15 µm

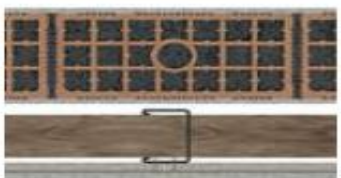

- Muratura
- Intercapedine 1 cm
- Profilo Knauf C50/75/100 mm
- Isolante Knauf in lana minerale
- 1+1 Lastra Knauf GKB, spessore 12,5 mm (A13) con interposta barriera al vapore in lamina di alluminio spessore 15 µm



- Muratura
- Isolante
- Isolastra Knauf LM/PSE/XPS/FPE



Contropareti interne ad incollaggio diretto

Rivestimento isolante W624

Controparete Diamant[®] - FPE

Novità



Controparete interna formata da Lastra Diamant[®]-FPE 20

Incollata tramite adesivo a base gesso **Knauf Perfix** su laterizio forato da 8 cm con 1,5 cm di intonaco per lato.

Potere fonoisolante: **55 dB**

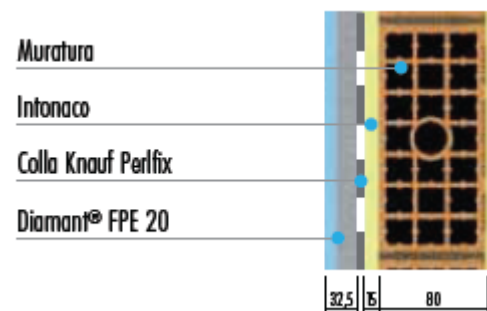

Controsoffitto in aderenza D111

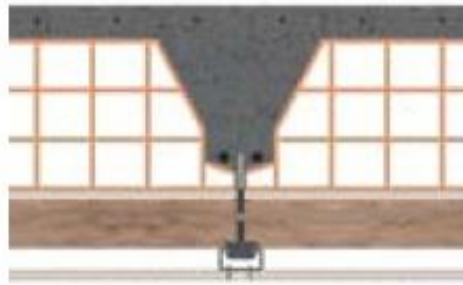

- Solaio
- Isolante
- Profilo Knauf C Plus 27/50/27 mm, ad interasse 500 mm
- Lastra Knauf GKB, spessore 12,5 mm con barriera al vapore in lamina di alluminio spessore 15 µm



SILENTBOARD

Rw 49 dB



Rw 63 dB



Rw > 68 dB

Ln,w 88 dB



Ln,w 61 dB



Ln,w 53 dB

Controsoffitto ribassato D112

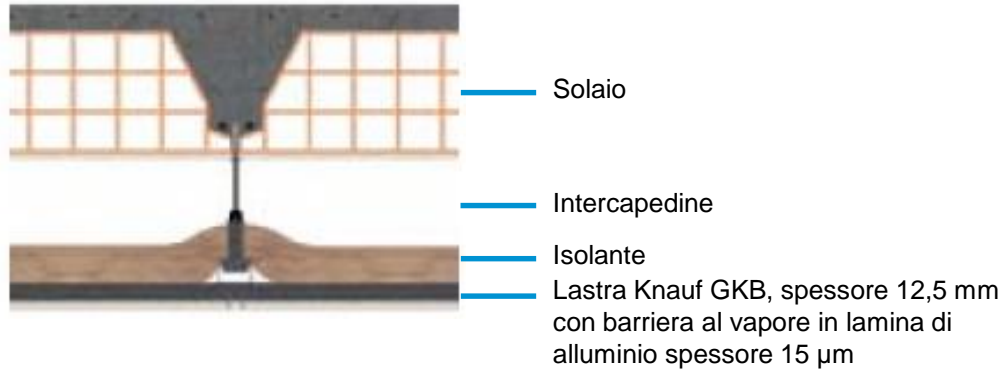

SILENTBOARD

Rw 49 dB	→	Rw 69 dB	→	Rw > 70 dB
Ln,w 88 dB	→	Ln,w 50 dB	→	Ln,w 45 dB

Parete KNAUF W 112

Singola struttura e doppia lastra di rivestimento

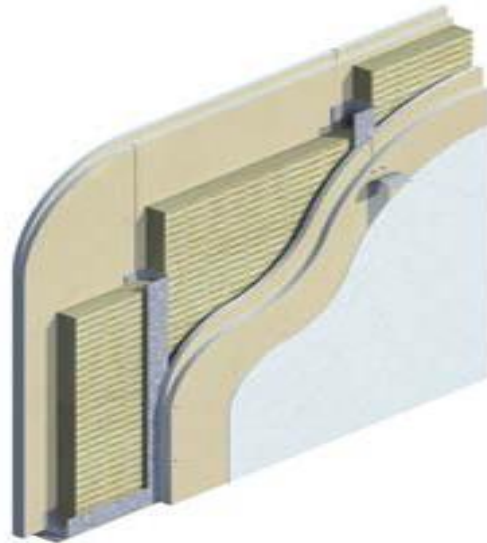

Rw 54 dB

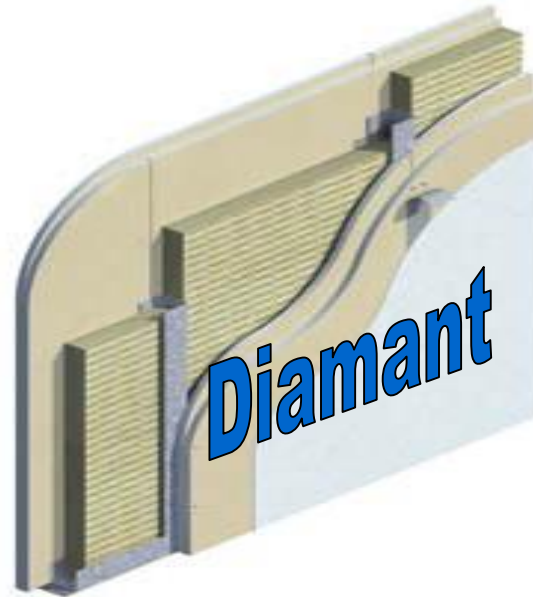

Rw 56 dB



Rw 66 dB

Spessore parete: 12,5 cm

Parete KNAUF W 115

Doppia struttura e doppia lastra di rivestimento

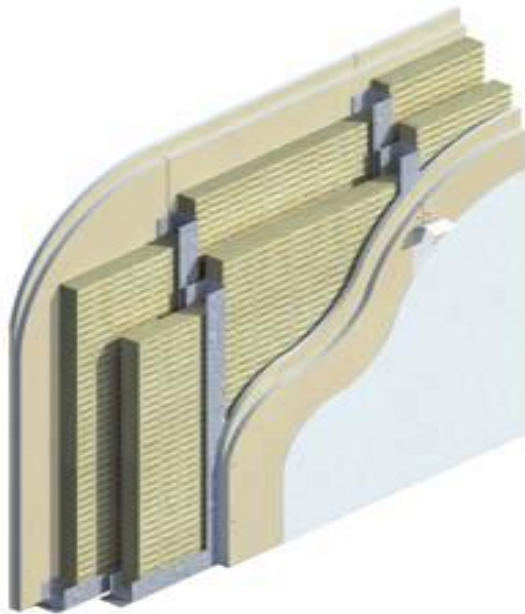

Rw 61 dB



Rw 67 dB



Rw 74 dB

Spessore parete: 21 cm

SISTEMA ISOLAMENTO TERMOACUSTICO PER INTERNI : TIPOLOGIE MASSETTI A SECCO

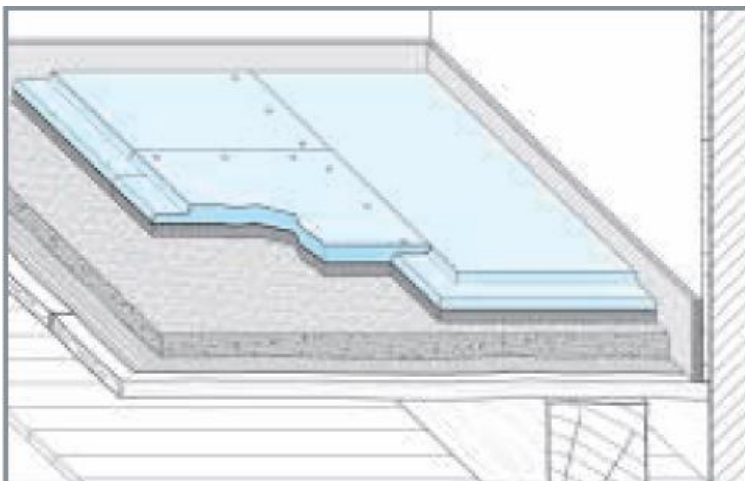

F 126 BRIO

Lastra in gessofibra 18-23 mm con o senza fibra di legno preaccoppiata da posare su granulare o su struttura

Lastra in gessofibra può essere fresata per l'alloggiamento della tubazione radiante

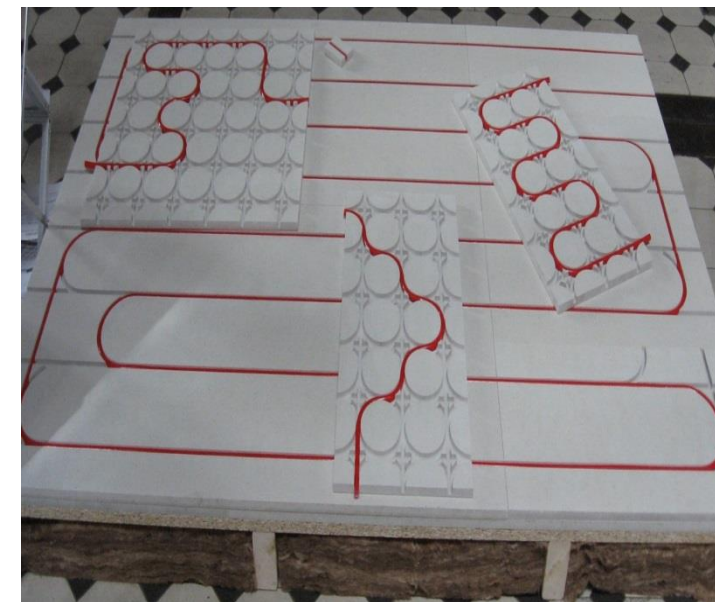

Nuovo BDS 3.0 *Sistema di progettazione e preventivazione*



Utilizza il sistema BDS per progettare e preventivare i sistemi costruttivi Knauf, sfruttando le potenzialità online del BDS.
Accedi ORA per iniziare un preventivo o analizzare un capitolato.

Accedi **ORA**
al servizio on-line



NOVITA'



PROGETTISTA 24

L'innovativo servizio on line per progettisti



www.progettista24.it



Technical Sales Manager Emilia Romagna-Marche

Ing. Jonathan Di Tommaso –Mobile: 335-6987912

ditommaso.jonathan@knauf.it

tour.edilportale.com



edilportale[®]

TOUR 2018

grazie per l'attenzione

tour.edilportale.com

